

2026  
COLLECTION

**SombriLLas** mx

[WWW.SOMBRILLASMEXICO.COM](http://WWW.SOMBRILLASMEXICO.COM)



Con más de 10 años de experiencia en la creación y distribución de sombrillas de alta calidad para exteriores, en **Sombrillas México®** nos hemos consolidado como una empresa comprometida con el diseño, la innovación y la durabilidad.

Nuestra pasión y el cuidado en cada detalle nos permiten ofrecer productos que combinan estética sofisticada, funcionalidad y resistencia, ideales para transformar cualquier espacio exterior en un lugar funcional y elegante.

Cada sombrilla que fabricamos refleja nuestra búsqueda constante de excelencia, garantizando soluciones de sombra que superan las expectativas de nuestros clientes, nos adaptamos a las necesidades de cada cliente, ofreciendo la posibilidad de crear sombrillas personalizadas.



# PROYECTOS

# Sombrillas mx

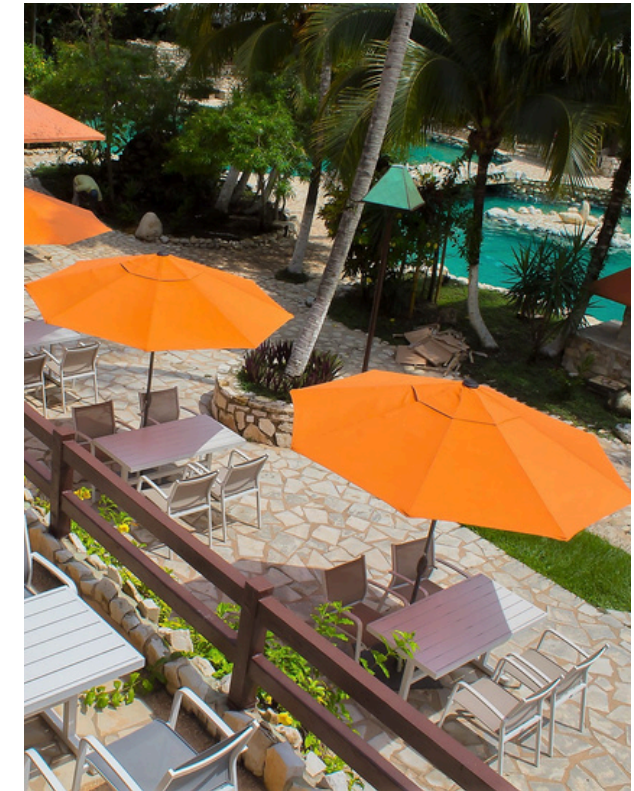
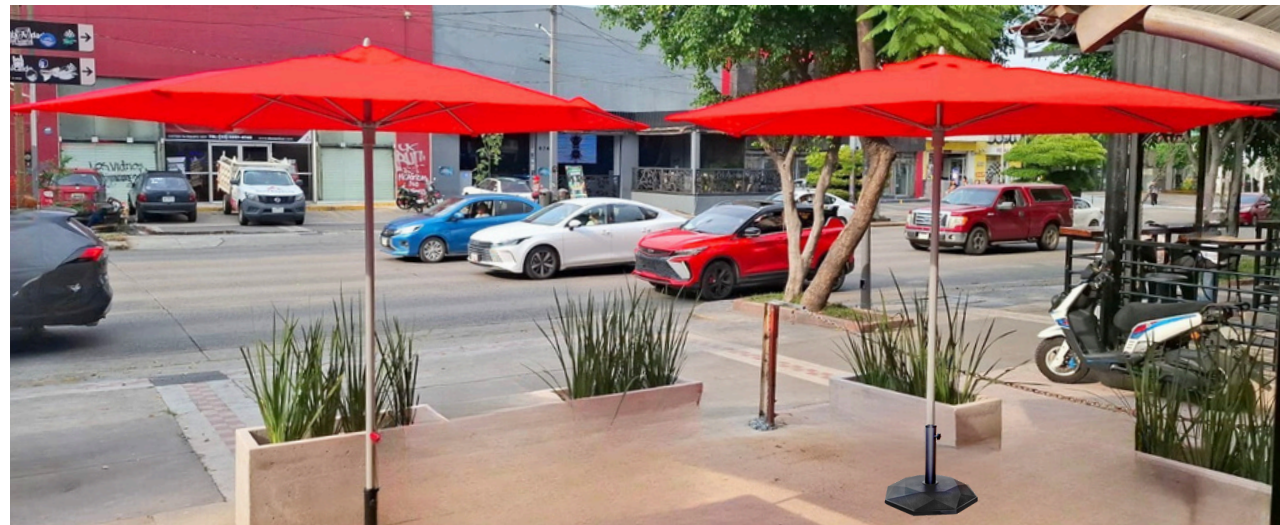
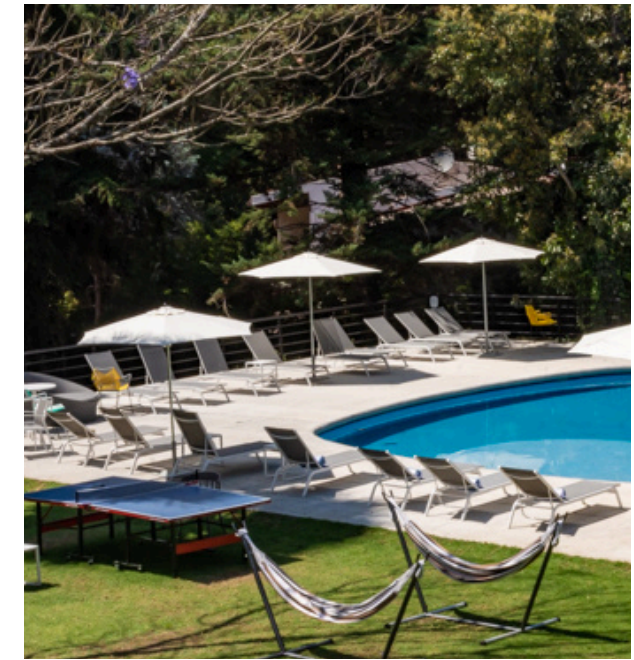
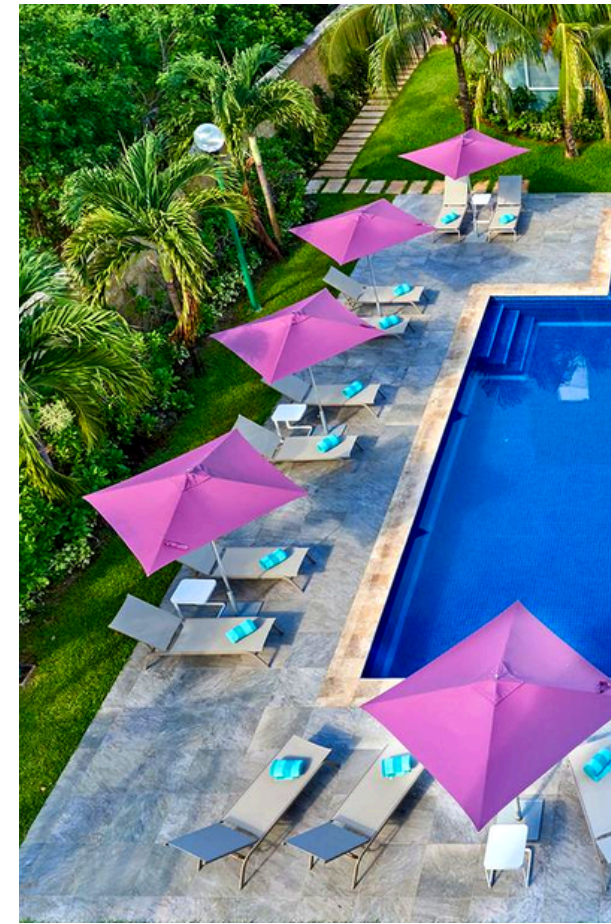

Resistencia al viento : Nivel 2 (ligero)

Resistencia a la decoloración : Nivel 1 (mínimo)

**CARACTERÍSTICAS**

- Poste de acero con polvo anticorrosivo 33.5/36.5 mm
- 8 varillas de acero de 4.5mm con sistema de inclinación manual con botón
- Tela: Poliéster 220g/m2
- Colores: Vainilla. Taupe y Gris
- Forma: Hexagonal

NO INCLUYE BASE

**DIMENSIONES**

- Sombrilla: 2.20 m X 2.20 m

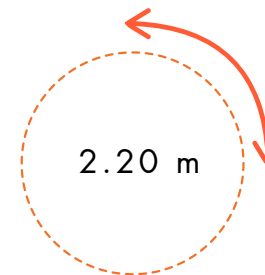
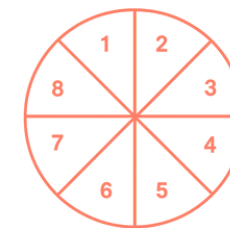

BASE DE RESINA | 19.5 KG  
RECOMENDACIÓN



BASE DE RESINA | 24.5 KG  
RECOMENDACIÓN

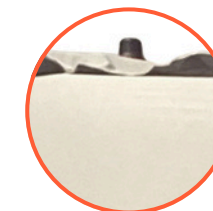

VAINILLA



TAUPE



GRIS



POLIÉSTER

# SOMBRILLA DE MADERA

SIENA

Resistencia al viento: Nivel 4 (Alto)

Resistencia a la decoloración: Nivel 1 (Mínimo)

## CARACTERÍSTICAS

- Poste central madera 48 mm
- 8 varillas de madera 20 x 30 mm
- Toldo poliéster Teñido en masa

No incluye base

## DIMENSIONES

Sombrilla: 2.5m x 2.5m

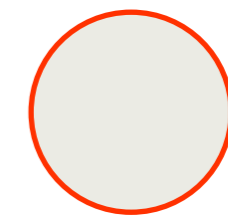
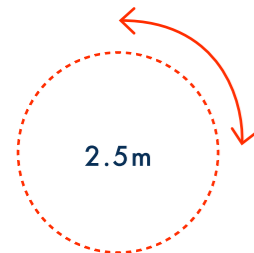
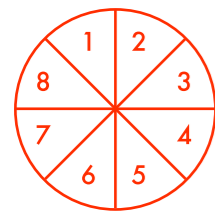

Beige

POLIÉSTER

# SOMBRILLA DE MADERA

# TORINO

Resistencia al viento: Nivel 3 (Alto)

Resistencia a la decoloración: Nivel 1 (Mínimo)

## CARACTERÍSTICAS

- Poste central madera 38 mm
- 8 varillas de madera 17 x 22 mm
- Toldo poliéster Teñido 19 g/m2

No incluye base

## DIMENSIONES

Sombrilla: 2.7m x 2.7m

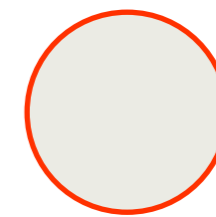
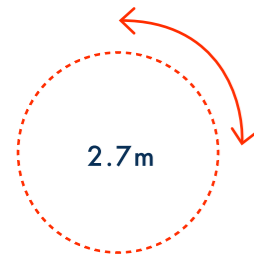
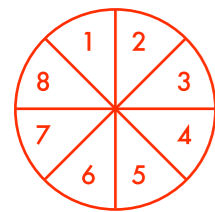

Beige

POLIÉSTER

Resistencia al viento : Nivel 4 (alto)

Resistencia a la decoloración : Nivel 4 (alto)

**CARACTERÍSTICAS**

- Poste de aluminio con polvo anticorrosivo de 38x1 mm
- 8 varillas de fibra de vidrio de 12.5 mm
- Tela: O'Bravia 2
- Color: Khaki, Negro, Gris, Taupe y Vainilla
- Forma: Redonda

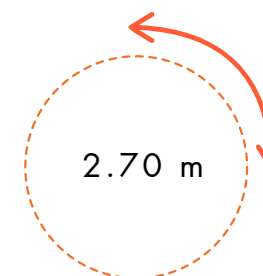
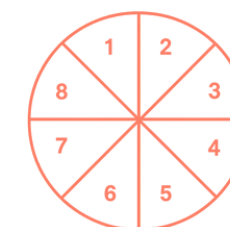

NO INCLUYE BASE

**DIMENSIONES**

- Sombrilla: 2.70 m X 2.70 m



BASE DE RESINA | 24.5 KG

RECOMENDACIÓN



BASE DE RESINA | 30 KG

RECOMENDACIÓN



KHAKI



NEGRO



GRIS



TAUPE



VAINILLA



POLIÉSTER



Resistencia al viento : Nivel 4 (alto)

Resistencia a la decoloración : Nivel 4 (alto)



BASE DE RESINA | 24.5 KG

RECOMENDACIÓN



BASE DE RESINA | 30 KG

RECOMENDACIÓN

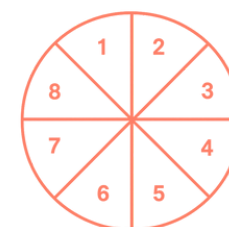

- Poste de aluminio con polvo anticorrosivo de 38x1 mm
- 8 varillas de fibra de vidrio de 12.5 mm
- Forma: Redonda

### CARACTERÍSTICAS

NO INCLUYE BASE

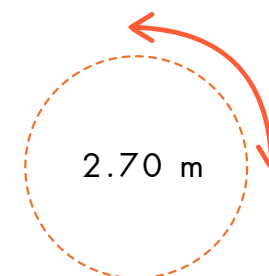

### DIMENSIONES

- Sombrilla: 2.70 m X 2.70 m

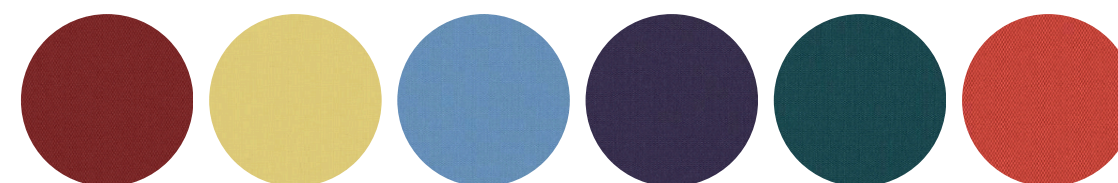

Resistencia al viento : Nivel 1 (mínimo)

Resistencia a la decoloración : Nivel 1 (mínimo)

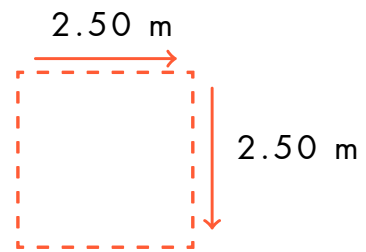
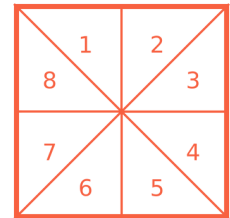

**CARACTERÍSTICAS**

- Armazón de aluminio con polvo anticorrosivo
- Poste lateral de 68x50 mm
- 8 varillas de acero de 13x22 mm
- Sistema de giro de 360 grados
- Base de resina de 4 piezas para rellenar con agua o arena
- Pesos total: 60 kg (agua) 80 kg (arena)
- Con funda
- Tela: Poliéster 220 g/m2
- Color: Avena
- Forma: Cuadrada

**DIMENSIONES**

- Sombrilla: 2.50 m x 2.50 m



AVENA

POLIÉSTER

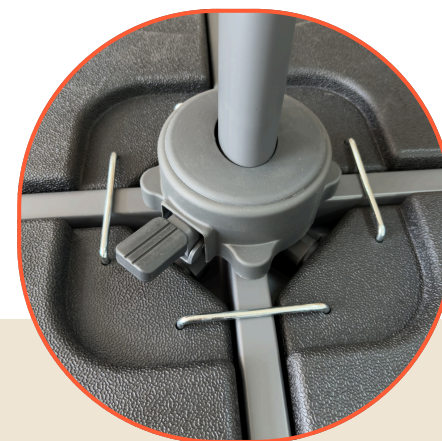
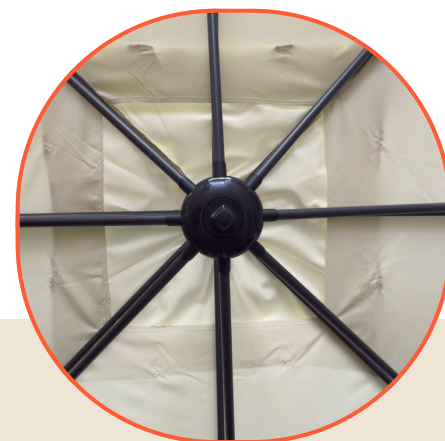

Resistencia al viento : Nivel 2 (ligero)

Resistencia a la decoloración : Nivel 4 (alto)

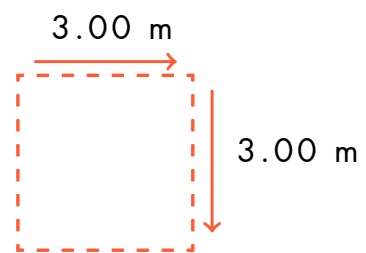
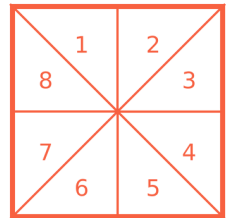

## CARACTERÍSTICAS

- Armazón de aluminio con polvo anticorrosivo
- Poste lateral de 77 x 53 mm
- 8 varillas de aluminio de 14 x 24 mm
- Sistema de giro de 360 grados
- Inclinación derecha/izquierda
- Base de resina para rellenar con agua o arena
- Peso total: 100 kg (agua) 135 kg (arena), con funda
- Tela: **Poliéster 250 g/m2 teñido en masa impermeable**
- Color: Gris, Beige
- Forma: Cuadrada

## DIMENSIONES

- Modelo Cuadrado : 3.00 m x 3.00 m



GRIS



BEIGE

POLIÉSTER

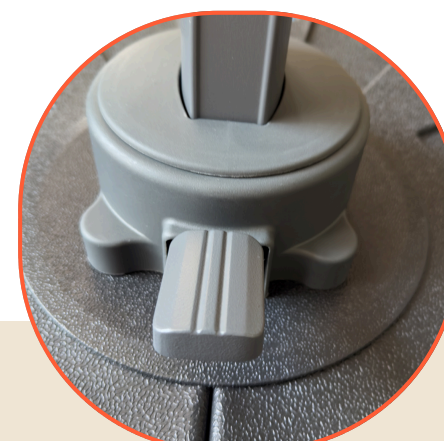

Resistencia al viento : Nivel 3 (medio)

Resistencia a la decoloración : Nivel 4 (alto)

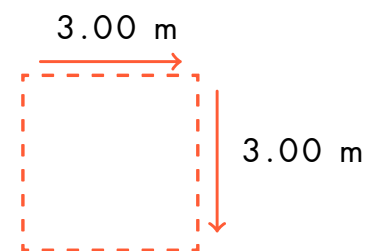
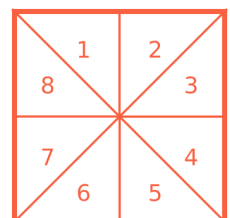

- CARACTERÍSTICAS**
- Armazón de aluminio con polvo anticorrosivo
  - Poste lateral de 100 x 60 mm
  - 8 varillas de aluminio de 33 x 20 mm
  - Sistema de giro de 360 grados
  - Inclinación derecha/izquierda
  - Base de resina para rellenar con agua o arena
  - Peso total: 150 kg (agua) 200 kg (arena)
  - Con funda
  - Tela: **Poliéster 250 g/m2 teñido en masa impermeable**
  - Color: Gris, Beige
  - Forma: Cuadrada

**DIMENSIONES**

- Sombrilla: 3.00 m x 3.00 m



GRIS



BEIGE

POLIÉSTER

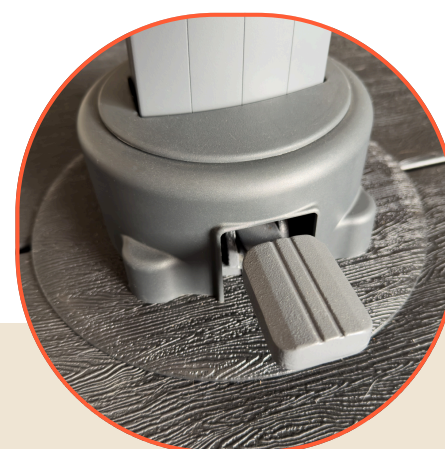
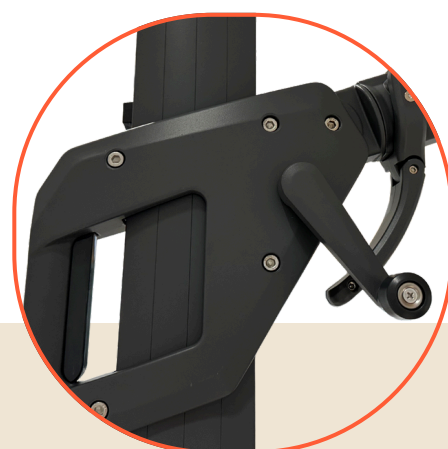

Resistencia al viento : Nivel 4 (alto)

Resistencia a la decoloración : Nivel 4 (alto)

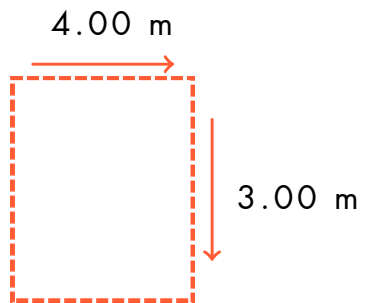
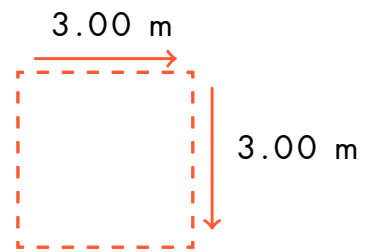
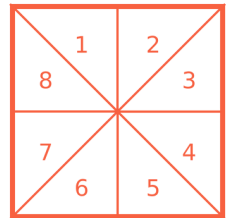

**CARACTERÍSTICAS**

- Armazón de aluminio acabado galvanizado mate
- Poste lateral de 100 x 60 mm
- 8 varillas de aluminio de 33 x 20 mm
- Sistema de giro de 360 grados
- Base de acero con llantas y 4 piezas de granito
- Peso total: 150 kg
- Con funda
- Tela: Acrílica teñida en masa
- Color: Beige, Gris
- Forma: Cuadrada

**DIMENSIONES**

- Modelo Cuadrado : 3.00 m x 3.00 m
- Modelo Rectangular : 4.00 m x 3.00 m



BEIGE

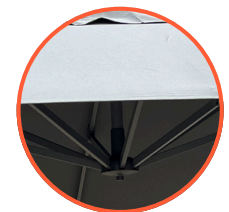

GRIS

ACRÍLICA TEÑIDA EN MASA

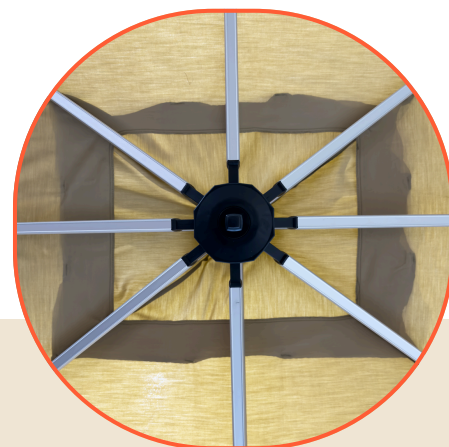

Resistencia al viento : Nivel 2 (ligero)

Resistencia a la decoloración : Nivel 1 (mínimo)

**CARACTERÍSTICAS**

- Poste de acero con polvo anticorrosivo 22/25 mm,
- 8 varillas de acero de 3.2 mm con sistema de inclinación ro-tilt
- Tela: Poliéster 180g/m2
- Color: Taupe, Vainilla, Gris
- Forma: Redonda

NO INCLUYE BASE

Es una sombrilla de playa (se entierra en la arena)

**DIMENSIONES**

- Sombrilla: 2.00 m X 2.00 m

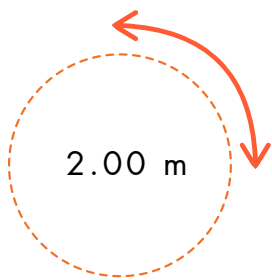
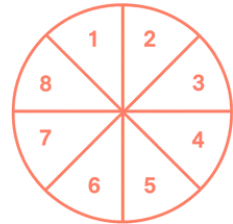

TAUPE



VAINILLA

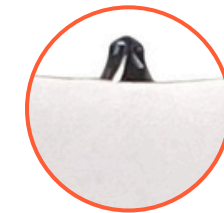

GRIS



POLIÉSTER

# BASES

---



BASE DE RESINA | 19.5 KG



BASE DE RESINA | 24.5 KG



BASE DE RESINA | 30 KG



BASE | 25 KG | DIAMANTE

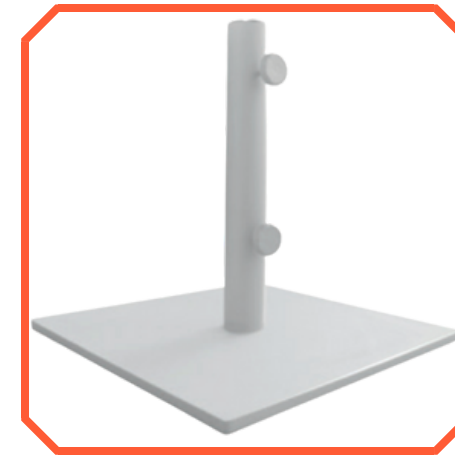

BASE | 31 KG | ACERO